

Ameron

Centrecon Pole Series

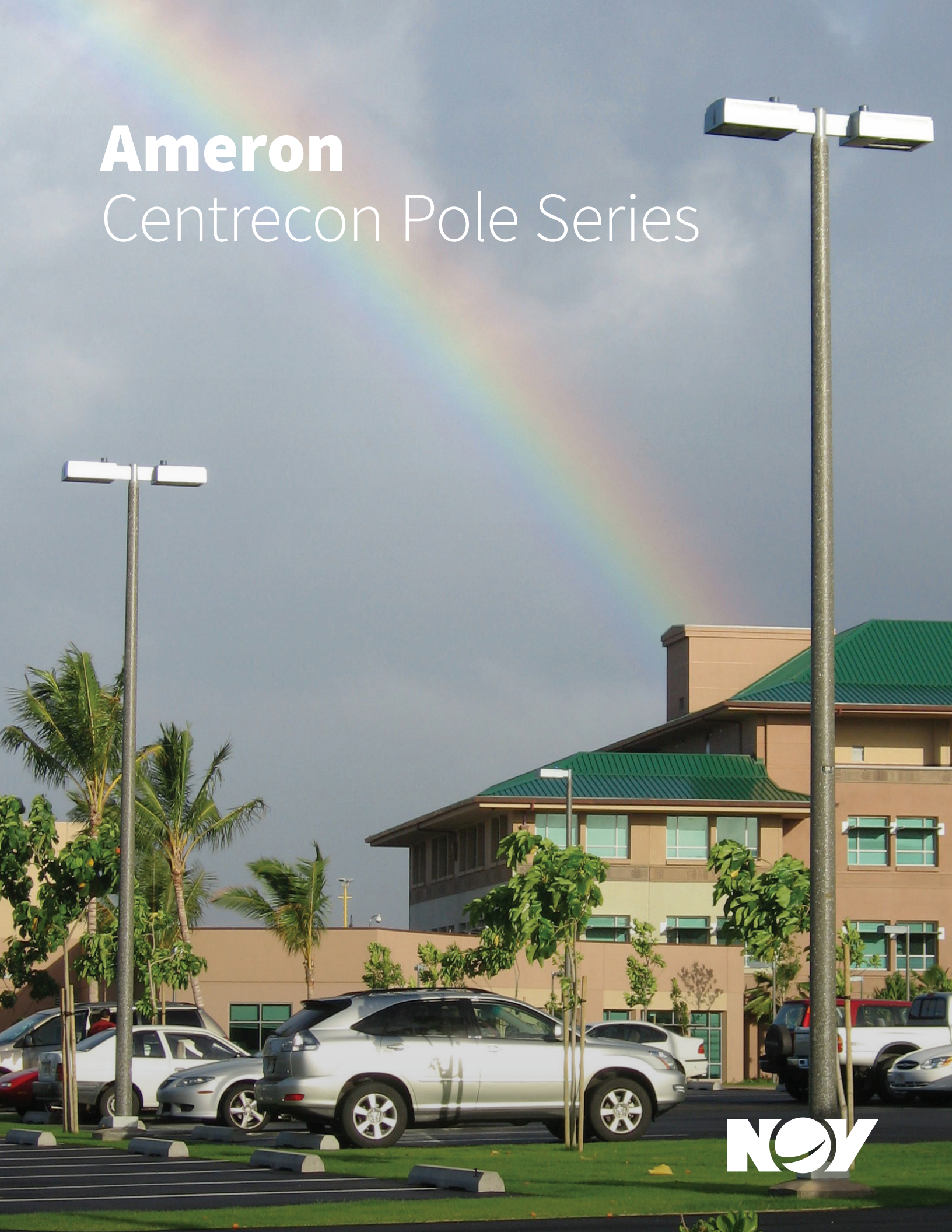

NOV





From **industrial** to **municipal**, we have the right pole for your project.

Table of Contents

| | |
|---|----|
| C-Series Octagonal Poles | 4 |
| H-Series Round Poles | 6 |
| L-Series Round Poles | 8 |
| M-Series Octagonal Poles - Base Plate | 10 |
| M-Series Octagonal Poles - Embedded | 12 |
| M-Series Round Poles - Embedded | 14 |
| M-Series Round Poles - Base Plate | 16 |
| M-Series Square Poles..... | 18 |
| S-Series Hexagonal Poles | 20 |
| S-Series Octagonal Poles..... | 22 |
| S-Series Round Poles | 24 |
| S-Series Square Poles | 26 |

Ameron

Centrecon C-Series Octagonal Poles

Available in base plate and embedded styles

Our Ameron™ Centrecon CBO and CEO tapered lighting poles provide the durable strength required for street lighting, shopping centers, parking lots, and area security. Application can be post top, mast arm, or side mounted.

Features and Benefits

- High tensile steel cables, a welded wire cage, and high-strength centrifugally cast concrete provide optimum strength and torsional reinforcement
- Prestressed spun-cast concrete provides long-term durability and vibration resistance
- Natural stone and terrazzo aggregates maintain a like-new appearance with virtually no maintenance
- Conforms to applicable sections of ACI, AASHTO, ASTM, and IBC standards
- Exclusive 10-year warranty

Colors and Finishes

A wide range of standard, preformulated, and custom colors are available. The concrete shafts are lightly blasted to expose the texture and color of the natural stone. See separate aggregates and finishes sheet for details. We offer Amershield™, a premium graffiti-resistant coating, as well as other durable sealers and protectants that further enhance colors, protect the concrete surface, and aid in the removal of graffiti.

Durability with a classic touch



Ameron Centrecon CBO and CEO Octagonal Poles

5 7/8" top OD
across the flats

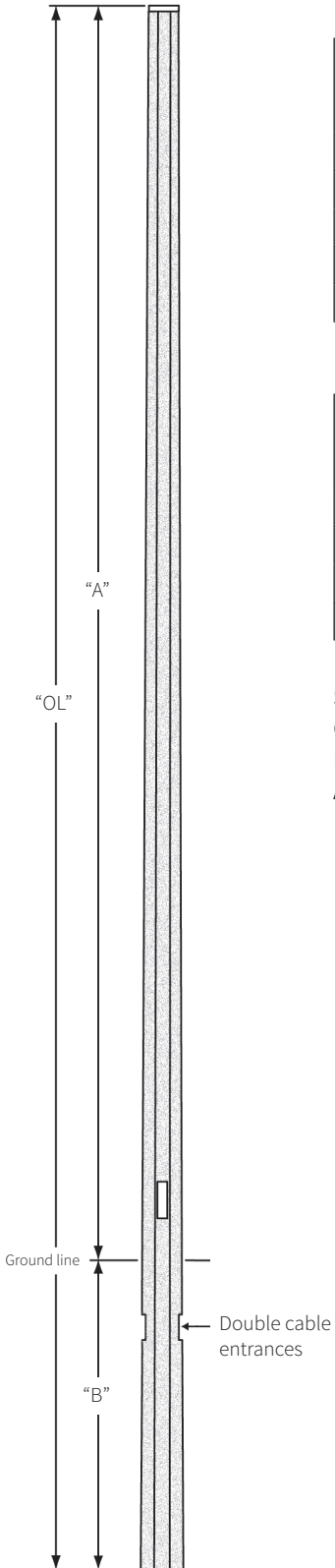

Base plate style - information

| Catalog number | Pole height "A" | Base OD | Anchor bolt | Bolt circle | Base plate (Sq) | Ultimate GL moment (ft/lb) | Pole weight (lb) |
|----------------|-----------------|---------|-------------------|-------------|-----------------|----------------------------|------------------|
| CBOX07 | 23' | 8 1/16" | 1" x 36" x 4" | 12 1/2" | 12" | 28,200 | 920 |
| CBOX08.5 | 27'11" | 9 1/4" | 1" x 36" x 4" | 12 1/2" | 12" | 32,500 | 1,160 |
| CBOX09.0 | 29'6" | 9 7/16" | 1" x 36" x 4" | 12 1/2" | 12" | 34,800 | 1,250 |
| CBOX09.8 | 32' | 9 3/4" | 1" x 36" x 4" | 12 1/2" | 12" | 35,500 | 1,380 |
| CBOX11.3 | 37' | 10 3/8" | 1 1/4" x 48" x 4" | 14" | 14" | 40,300 | 1,670 |

Embedded style - information

| Catalog number | Pole height "A" | Bottom OD | Embedded depth "B" | Overall length "OL" | Ultimate GL moment (ft/lb) | Pole weight (lb) |
|----------------|-----------------|-----------|--------------------|---------------------|----------------------------|------------------|
| CEOX07 | 23' | 9 1/4" | 4'10" | 27'10" | 28,200 | 1,100 |
| CEOX08.2 | 27' | 9 3/4" | 5" | 32' | 32,500 | 1,330 |
| CEOX08.5 | 27'10" | 9 3/4" | 5" | 32'10" | 33,000 | 1,380 |
| CEOX09.5 | 31' | 10 3/8" | 6" | 37' | 34,900 | 1,620 |

Specifications: Use Centrecon specifications.

Colors and Finishes: See Centrecon color selection guide.

Luminaire Mounting: See mounting options section for more information.

Anti-graffiti and sealer: Optional coatings available for added protection.

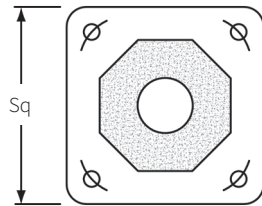

Slotted base plate
prestressed to pole

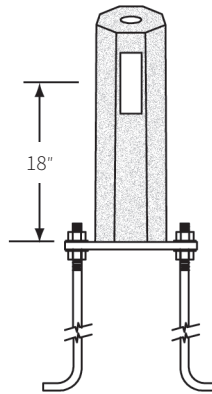

Elevation
See recommended
"Capping Details"

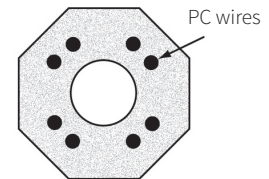

Shaft cross section detail

Ameron Centrecon H-Series Round Poles

Available in base plate and embedded styles

Our Ameron Centrecon H-Series prestressed, spun-cast concrete lighting poles provide strength required for most stadiums, raceways, roadways, and parking lots. Application can be post top or side mounted. These huge, strong, durable poles are available in various aggregates and finishes.

Features and Benefits

- High tensile steel cables, a welded wire cage, and high-strength centrifugally cast concrete provide optimum strength and torsional reinforcement.
- Prestressed spun-cast concrete provides long-term durability and vibration resistance
- Natural concrete, stone and terrazzo aggregates maintain a like-new appearance with virtually no maintenance
- Conforms to applicable sections of ACI, AASHTO, ASTM, and IBC standards
- 10-year warranty

Colors and Finishes

A wide range of standard, preformulated, and custom colors are available. The concrete shafts are lightly blasted to expose the texture and color of the natural stone. See separate aggregates and finishes sheet for details. We offer Amershield a premium graffiti-resistant coating, as well as other durable sealers and protectants that further enhance colors, protect the concrete surface, and aid in the removal of graffiti.

Durability with a classic touch



Ameron Centrecon H-Series Round Poles

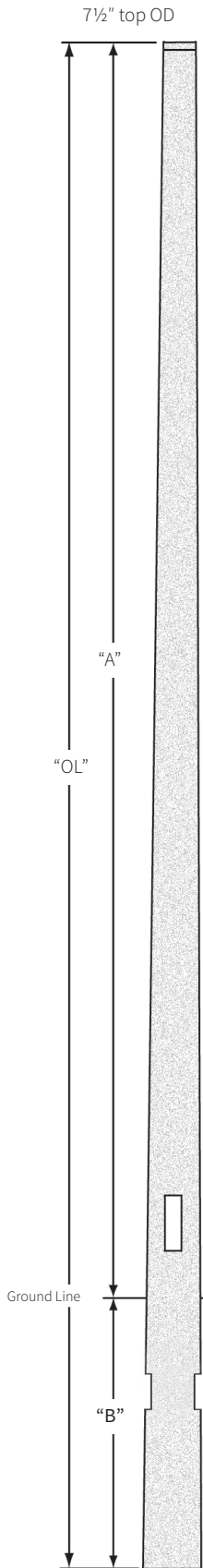

Base plate style - information

| Catalog number | Pole height "A" | Base OD | Anchor bolt | Bolt circle | Base plate (Sq) | Ultimate GL moment (ft/lb) | Pole weight (lb) |
|----------------|-----------------|---------|-------------------|-------------|-----------------|----------------------------|------------------|
| HBRX12* | 39'4" | 13 1/4" | 1 1/4" x 48" x 4" | 17 1/2" | 17" | 96,000 | 2,550 |
| HBRX13* | 42'8" | 14 1/4" | 1 1/4" x 48" x 4" | 18 1/2" | 18" | 102,000 | 2,850 |
| HBRX14* | 45'11" | 14 1/2" | 1 1/2" x 54" x 6" | 19" | 18 1/2" | 109,000 | 3,200 |
| HBRX15* | 49'2" | 15 3/8" | 1 1/2" x 54" x 6" | 19 1/2" | 19" | 116,600 | 3,500 |
| HBRX16* | 52'6" | 15 7/8" | 1 1/2" x 54" x 6" | 20" | 20" | 123,600 | 3,850 |

ASTM, A449 anchor bolts with bearing plates may be required for development of full pole capacity.

Embedded style - information

| Catalog number | Pole height "A" | Bottom OD | Embedded depth "B" | Overall length "OL" | Ultimate GL moment (ft/lb) | Pole weight (lb) |
|----------------|-----------------|-----------|--------------------|---------------------|----------------------------|------------------|
| HERX10.2* | 33'5" | 13 1/4" | 5'11" | 39'4" | 82,400 | 2,450 |
| HERX11.1* | 36'5" | 14 1/4" | 6'3" | 42'8" | 88,500 | 2,750 |
| HERX12* | 39'4" | 14 1/2" | 6'7" | 45'11" | 96,000 | 3,100 |
| HERX12.8* | 42' | 15 3/8" | 7'2" | 49'2" | 101,000 | 3,400 |
| HERX13.7* | 45' | 15 7/8" | 7'6" | 52'6" | 107,000 | 3,750 |

*The H-Series poles are only available from the Everett Plant.

Specifications: Use Centrecon specifications.

Colors and finishes: See Centrecon mix colors.

Luminaire mounting: See technical-mounting options section for more information.

Anti-graffiti and sealer: Optional coatings available for added protection.

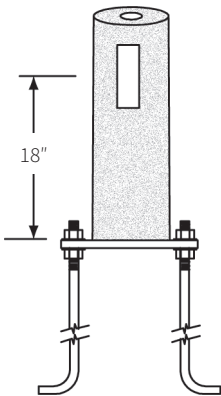

Elevation
See recommended "Capping Details"

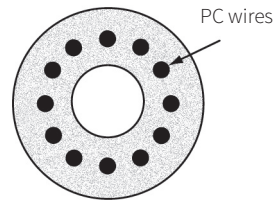

Shaft cross section detail

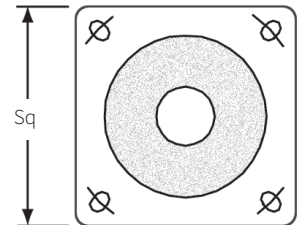

Standard base plate prestressed to pole

Ameron

Centrecon

L-Series Round Poles

Available in base plate and embedded styles

Our Ameron Centrecon LBR and LER tapered lighting poles provide the durable strength required for roadway lighting, parking lots, stadiums, and area security. Application can be post top, mast arm, or side mounted.

Features and Benefits

- High tensile steel cables, a welded wire cage, and high-strength centrifugally cast concrete provide optimum strength and torsional reinforcement
- Prestressed spun-cast concrete provides long-term durability and vibration resistance
- Natural stone and terrazzo aggregates maintain a like-new appearance with virtually no maintenance
- Conforms to applicable sections of ACI, AASHTO, ASTM, and IBC standards
- Exclusive 10-year warranty

Colors and Finishes

A wide range of standard, preformulated, and custom colors are available. The concrete shafts are blasted to expose the texture and color of the natural stone. See separate aggregates and finishes sheet for details. We offer Amershield, a premium graffiti-resistant coating, as well as other durable sealers and protectants that further enhance colors, protect the concrete surface, and aid in the removal of graffiti.

Durability with a classic touch



6 1/16" top OD

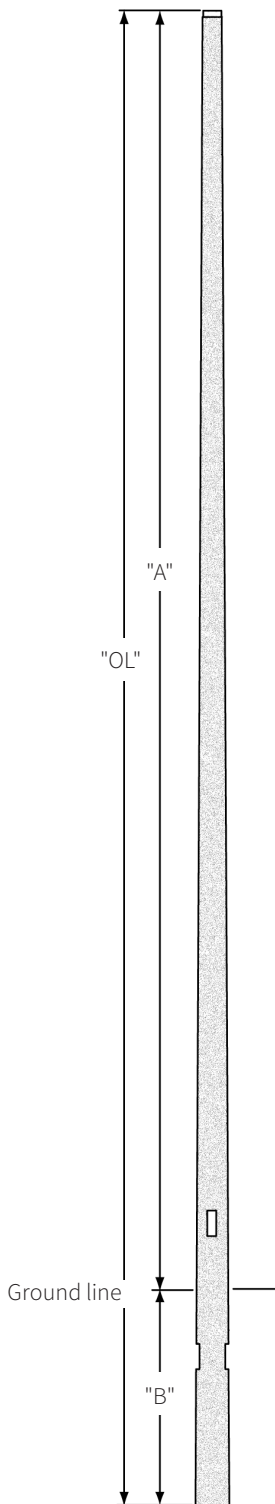

Base plate style - information

| Catalog number | Pole height "A" | Base OD | Anchor bolt | Bolt circle | Base plate (Sq) | Ultimate GL moment (ft/lb) | Pole weight (lb) |
|----------------|-----------------|----------|-------------------|-------------|-----------------|----------------------------|------------------|
| LBR09 | 29'6" | 11 3/8" | 1" x 36" x 4" | 16 1/2" | 16" | 48,300 | 1,550 |
| LBRX10 | 32'10" | 11 5/16" | 1" x 36" x 4" | 16 1/2" | 16" | 51,000 | 1,850 |
| LBRX11 | 36'1" | 12 7/16" | 1" x 36" x 4" | 16 1/2" | 16" | 54,700 | 2,150 |
| LBRX12 | 39'4" | 13" | 1 1/4" x 48" x 6" | 17 1/2" | 17" | 58,300 | 2,500 |
| LBRX13 | 42'8" | 13 1/2" | 1 1/4" x 48" x 6" | 17 1/2" | 17" | 62,000 | 2,850 |
| LBRX14 | 45'11" | 14" | 1 1/4" x 48" x 6" | 18 1/2" | 18" | 65,200 | 3,100 |
| LBRX15* | 49'2" | 14 5/16" | 1 1/4" x 48" x 6" | 18 1/2" | 18" | 69,400 | 3,500 |

Embedded style - information

| Catalog number | Pole height "A" | Bottom OD | Embedded depth "B" | Overall length "OL" | Ultimate GL moment (ft/lb) | Pole weight (lb) |
|----------------|-----------------|-----------|--------------------|---------------------|----------------------------|------------------|
| LER07.5 | 24'7" | 11 3/8" | 4'11" | 29'6" | 31,700 | 1,500 |
| LER08.4 | 27'7" | 11 5/16" | 5'3" | 32'10" | 36,000 | 2,000 |
| LERX09.3 | 30'6" | 12 7/16" | 5'7" | 36'1" | 38,600 | 2,400 |
| LERX10.2 | 33'5" | 13" | 5'11" | 39'4" | 51,800 | 2,800 |
| LERX11.1* | 36'5" | 13 1/2" | 6'3" | 42'8" | 55,000 | 3,000 |
| LERX12* | 39'4" | 14" | 6'7" | 45'11" | 58,300 | 3,200 |
| LERX12.9* | 42'3" | 14 5/16" | 6'11" | 49'2" | 61,600 | 3,500 |

*LBRX15, LERX11.1, LERX12 and LERX12.9 are only available from Everett, WA.

Specifications: Use Centrecon specifications.

Colors and finishes: See Centrecon color selection guide.

Luminaire mounting: See mounting options section for more information.

Anti-graffiti and sealer: Optional coatings available for added protection.

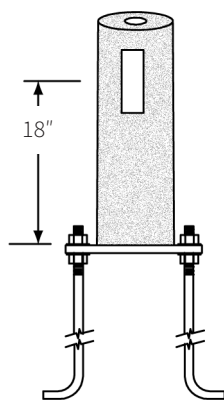

Elevation
See recommended "Capping Detail"

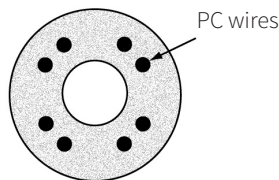

Shaft cross section detail

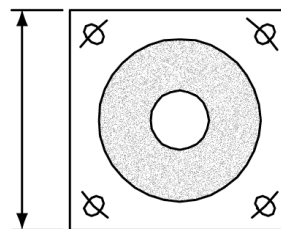

Standard base plate prestressed to pole

Ameron Centrecon M-Series Octagonal Poles - Base Plate

Also available in embedded style

Our Ameron Centrecon M-Series lighting poles provide the strength required for shopping centers, parking lots, and roadway lighting. Application can be post top, mast arm or side mounted.

Features and Benefits

- Prestressed steel and highest quality concrete are centrifugally cast for ultimate strength, durability, and vibration resistance
- Natural stone and terrazzo aggregates maintain a like-new appearance with virtually no maintenance
- Conforms to applicable sections of ACI, AASHTO, ASTM, and PCI standards
- Exclusive 10-year warranty

Colors and Finishes

A wide range of standard, preformulated, and custom colors are available. The concrete shafts are lightly blasted to expose the texture and beauty of the natural stone. See separate aggregates and finishes sheet for details. We offer Amershield, a premium graffiti-resistant coating, as well as other durable sealers and protectants that further enhance colors, protect the concrete surface, and aid in the removal of graffiti.

Durability with a classic touch



Ameron Centrecon M-Series Octagonal Poles - Base Plate

5/8" top OD
across the flats

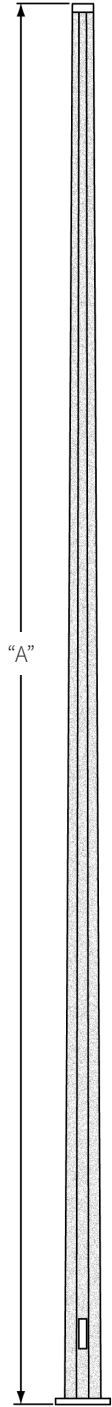

Base plate style - information

| Catalog number | Pole height "A" | Base OD | Anchor bolt | Bolt circle | Base plate (Sq) | Ultimate GL moment (ft/lb) | Pole weight (lb) |
|----------------|-----------------|---------|---------------|-------------|-----------------|----------------------------|------------------|
| MBO03 | 9'10" | 6 7/16" | 1" x 36" x 4" | 11 1/2" | 11" | 13,700 | 250 |
| MBO04.3 | 14'1" | 6 3/16" | 1" x 36" x 4" | 11 1/2" | 11" | 15,600 | 400 |
| MBO06 | 19'8" | 7 1/2" | 1" x 36" x 4" | 11 1/2" | 11" | 17,260 | 600 |
| MBO07 | 23' | 7 7/8" | 1" x 36" x 4" | 11 1/2" | 11" | 19,030 | 740 |
| MBO07.5 | 24'7" | 8 1/16" | 1" x 36" x 4" | 11 1/2" | 11" | 19,910 | 790 |
| MBO08 | 26'3" | 8 1/4" | 1" x 36" x 4" | 11 1/2" | 11" | 20,790 | 900 |
| MBO08.5 | 27'11" | 8 7/16" | 1" x 36" x 4" | 11 1/2" | 11" | 21,660 | 960 |
| MBO09 | 29'6" | 8 5/8" | 1" x 36" x 4" | 11 1/2" | 11" | 22,540 | 1,000 |
| MBOX09.5 | 31'2" | 8 7/8" | 1" x 36" x 4" | 11 1/2" | 11" | 29,500 | 1,100 |
| MBOX10 | 32'10" | 9 1/16" | 1" x 36" x 4" | 11 1/2" | 11" | 30,900 | 1,300 |
| MBOX10.6 | 34'9" | 9 5/16" | 1" x 36" x 4" | 14" | 13" | 32,500 | 1,375 |
| MBOX11.7 | 38'5" | 9 3/4" | 1" x 36" x 4" | 14" | 13" | 35,300 | 1,600 |

Specifications: Use Centrecon specifications.

Colors and finishes: See Centrecon color selection guide.

Luminaire mounting: See technical-mounting options section for more information.

Anti-graffiti and sealer: Optional coatings available for added protection.

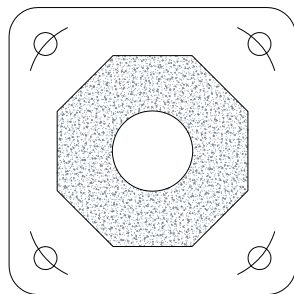

Slotted base plate
prestressed to pole

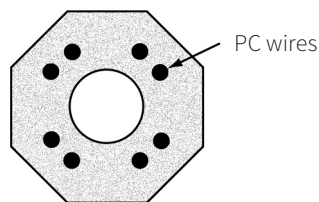

Shaft cross section detail

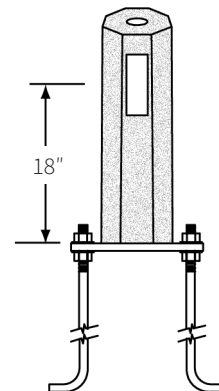

Elevation
See recommended
"Capping Details"

Ameron

Centrecon M-Series Octagonal Poles - Embedded

Also available in base plate style

Ameron Centrecon M-Series prestressed, spun-cast concrete lighting poles provide the strength required for shopping centers, parking lots, green belts, or other areas requiring decorative and roadway lighting. Application can be post top, mast arm, or side mounted. These strong, durable poles are available in various aggregates and finishes.

Features and Benefits

- Prestressed steel and highest quality concrete are centrifugally cast for ultimate strength, durability, and vibration resistance
- Natural stone and terrazzo aggregates maintain a like-new appearance with virtually no maintenance
- Conforms to applicable sections of ACI, AASHTO, ASTM, and PCI standards
- Exclusive 10-year warranty

Colors and Finishes

A wide range of standard, preformulated, and custom colors are available. The concrete shafts are lightly blasted to expose the texture and beauty of the natural stone. See separate aggregates and finishes sheet for details. We offer Amershield, a premium graffiti-resistant coating, as well as other durable sealers and protectants that further enhance colors, protect the concrete surface, and aid in the removal of graffiti.

Durability with a classic touch



Ameron Centrecon M-Series Octagonal Poles - Embedded

5/8" top OD
across the flats

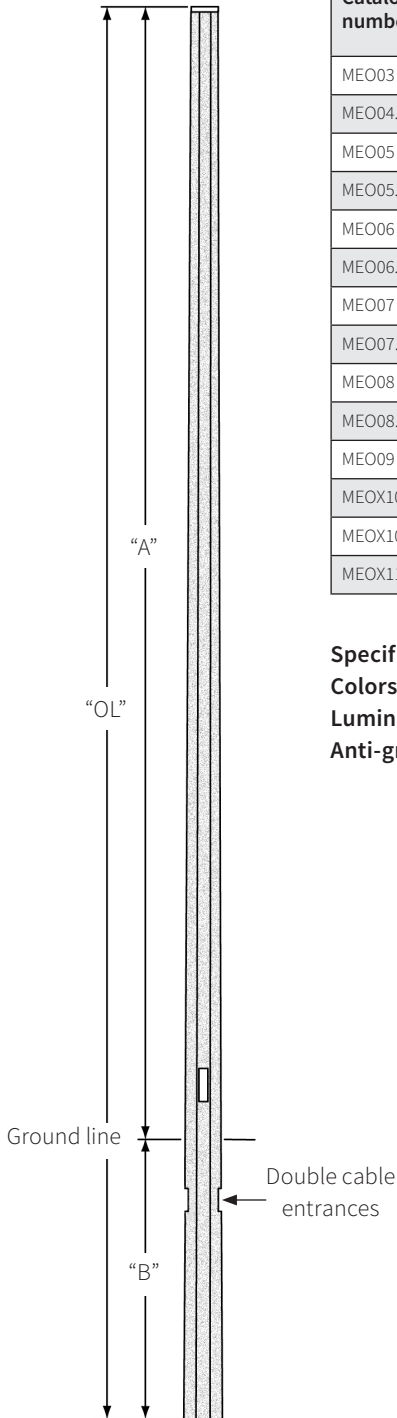

Embedded style - information

| Catalog number | Pole height "A" | Bottom OD | Embedded depth "B" | Overall length "OL" | Ultimate GL moment (ft/lb) | Pole weight (lb) |
|----------------|-----------------|-----------|--------------------|---------------------|----------------------------|------------------|
| MEO03 | 9'10" | 6 1/16" | 4'3" | 14'1" | 15,450 | 380 |
| MEO04.6 | 15' | 7 1/2" | 4'8" | 19'8" | 12,840 | 575 |
| MEO05 | 16'5" | 7 1/2" | 4'3" | 20'8" | 15,450 | 690 |
| MEO05.5 | 18' | 7 7/8" | 5' | 23' | 17,000 | 720 |
| MEO06 | 19'7" | 8" | 4'3" | 23'10" | 17,440 | 750 |
| MEO06.5 | 21'3" | 8 3/16" | 5' | 26'3" | 18,235 | 870 |
| MEO07 | 23' | 8 3/8" | 4'7" | 27'7" | 19,030 | 900 |
| MEO07.5 | 24'7" | 8 9/16" | 4'11" | 29'6" | 19,910 | 980 |
| MEO08 | 26'3" | 8 3/16" | 4'11" | 31'2" | 20,790 | 1,100 |
| MEO08.5 | 27'11" | 9" | 4'11" | 32'10" | 21,660 | 1,250 |
| MEO09 | 29'6" | 9 1/4" | 5'3" | 34'9" | 22,540 | 1,300 |
| MEOX10 | 32'10" | 9 3/4" | 5'7" | 38'5" | 30,900 | 1,500 |
| MEOX10.6 | 34'8" | 10" | 5'11" | 40'7" | 32,500 | 1,600 |
| MEOX11.1 | 36'6" | 10 1/4" | 6'6" | 43' | 33,900 | 1,700 |

Specifications: Use Centrecon specifications.

Colors and finishes: See Centrecon color selection guide.

Luminaire mounting: See mounting options section for more information.

Anti-graffiti and sealer: Optional coatings available for added protection.

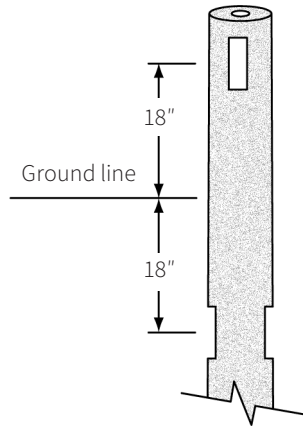

Elevation

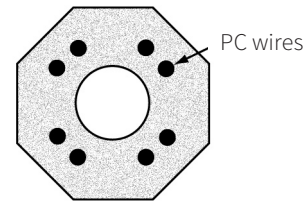

Shaft cross section detail

Ameron Centrecon M-Series Round Poles - Embedded

Also available in base plate style

Our Ameron Centrecon M-Series prestressed, spun-cast concrete lighting poles provide the strength required for most shopping centers, parking lots, green belts, or other areas requiring decorative and roadway lighting. Application can be post top, mast arm, or side mounted. These strong, durable poles are available in various aggregates and finishes.

Features and Benefits

- Prestressed steel and highest quality concrete are centrifugally cast for ultimate strength, durability, and vibration resistance
- Natural stone and terrazzo aggregates maintain a like-new appearance with virtually no maintenance
- Conforms to applicable sections of ACI, AASHTO, ASTM, and PCI standards
- Exclusive 10-year warranty

Colors and Finishes

A wide range of standard, preformulated, and custom colors are available. The concrete shafts are lightly blasted to expose the texture and beauty of the natural stone. See separate aggregates and finishes sheet for details. We offer Amershield, a premium graffiti-resistant coating, as well as other durable sealers and protectants that further enhance colors, protect the concrete surface, and aid in the removal of graffiti.

Durability with a classic touch



Ameron Centrecon M-Series Round Poles - Embedded

Embedded style - information

| Catalog number | Pole height "A" | Bottom OD | Embedded depth "B" | Overall length "OL" | Ultimate GL moment (ft/lb) | Pole weight (lb) |
|----------------|-----------------|-----------|--------------------|---------------------|----------------------------|------------------|
| MER02.6* | 8'8" | 7" | 3'2" | 11'1" | 7,000 | 260 |
| MER02.6* | 10'9" | 7¼" | 3'4" | 14'1" | 9,000 | 320 |
| MER04.3* | 14' | 8¼" | 5'8" | 19'8" | 14,000 | 600 |
| MER05.2* | 17' | 7⅞" | 5' | 22' | 14,000 | 680 |
| MER06 | 19'8" | 8" | 4'11" | 24'7" | 17,440 | 750 |
| MER07 | 23' | 8⅜" | 4'7" | 27'7" | 19,030 | 850 |
| MER07.5 | 24'7" | 8⅞" | 4'11" | 29'6" | 19,910 | 950 |
| MER08 | 26'3" | 8⅜" | 4'11" | 31'2" | 20,790 | 1,050 |
| MER08.5 | 27'11" | 9" | 4'11" | 32'10" | 21,660 | 1,150 |
| MER09 | 29'6" | 9¼" | 5'3" | 34'9" | 22,540 | 1,200 |
| MERX10 | 32'10" | 9¾" | 5'7" | 38'5" | 30,800 | 1,650 |
| MERX11 | 36' | 11⅝" | 6'8" | 42'8" | 42,200 | 2,100 |
| MERX12 | 39'4" | 12⅞" | 6'7" | 45'11" | 47,500 | 2,500 |
| MERX13 | 42'8" | 13" | 6'6" | 49'2" | 49,300 | 2,850 |
| MERX13.9 | 45'7" | 13½" | 6'11" | 52'6" | 52,700 | 3,000 |

*MER02.6, MER03.2, MER04.3, and MER05.2 have a smaller HH opening.

Specifications: Use Centrecon specifications.

Colors and finishes: See Centrecon color selection guide.

Luminaire mounting: See mounting options section for more information.

Anti-graffiti and sealer: Optional coatings available for added protection.

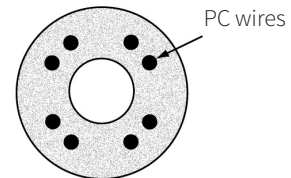
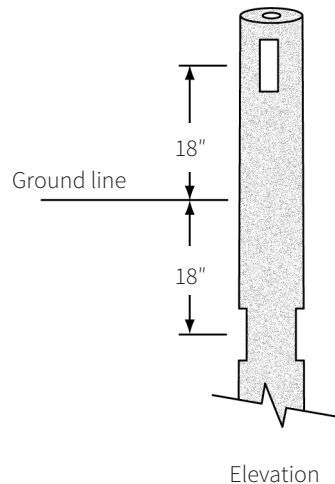
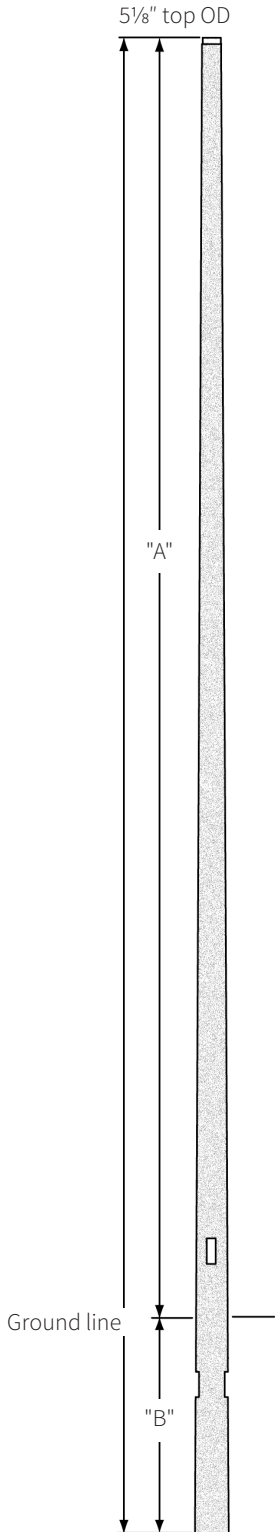

Ameron

Centrecon M-Series Round Poles - Base Plate

Also available in embedded style

Our Ameron Centrecon M-Series prestressed, spun-cast concrete lighting poles provide the strength required for most shopping centers, parking lots, green belts, or other areas requiring decorative and roadway lighting. Application can be post top, mast arm, or side mounted. These strong, durable poles are available in various aggregates and finishes.

Features and Benefits

- Prestressed steel and highest quality concrete are centrifugally cast for ultimate strength, durability, and vibration resistance
- Natural stone and terrazzo aggregates maintain a like-new appearance with virtually no maintenance
- Conforms to applicable sections of ACI, AASHTO, ASTM, and PCI standards
- Exclusive 10-year warranty

Colors and Finishes

A wide range of standard, preformulated, and custom colors are available. The concrete shafts are lightly blasted to expose the texture and beauty of the natural stone. See separate aggregates and finishes sheet for details. We offer Amershield, a premium graffiti-resistant coating, as well as other durable sealers and protectants that further enhance colors, protect the concrete surface, and aid in the removal of graffiti.

Durability with a classic touch



Ameron Centrecon M-Series Round Poles - Base Plate

5 1/8" top OD

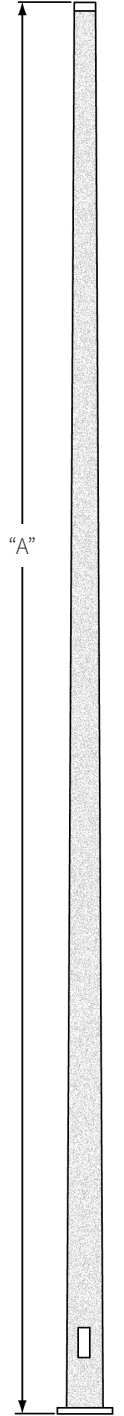

Base plate style - information

| Catalog number | Pole height "A" | Base OD | Anchor bolt | Bolt circle | Base plate (Sq) | Ultimate GL moment (ft/lb) | Pole weight (lb) |
|----------------|-----------------|-----------|---------------|-------------|-----------------|----------------------------|------------------|
| MBR03.6 | 11'10" | 7" | 1" x 36" x 4" | 11 1/2" | 11" | 9,000 | 475 |
| MBR04.3 | 14'1" | 7" | 1" x 36" x 4" | 11 1/2" | 11" | 9,000 | 525 |
| MBR06 | 19'8" | 8 1/4" | 1" x 36" x 4" | 11 1/2" | 11" | 20,100 | 600 |
| MBR07 | 23' | 7 7/8" | 1" x 36" x 4" | 11 1/2" | 11" | 19,030 | 680 |
| MBR07.5 | 24'7" | 8 1/16" | 1" x 36" x 4" | 11 1/2" | 11" | 19,910 | 750 |
| MBR08 | 26'3" | 8 1/4" | 1" x 36" x 4" | 11 1/2" | 11" | 20,790 | 825 |
| MBR08.5 | 27'11" | 8 7/16" | 1" x 36" x 4" | 11 1/2" | 11" | 21,660 | 875 |
| MBR09 | 29'6" | 8 5/8" | 1" x 36" x 4" | 11 1/2" | 11" | 22,540 | 920 |
| MBRX09.5 | 31'2" | 8 7/8" | 1" x 36" x 4" | 11 1/2" | 11" | 34,000 | 1,050 |
| MBRX10 | 32'10" | 9 1/16" | 1" x 36" x 4" | 11 1/2" | 11" | 35,000 | 1,150 |
| MBRX10.6 | 34'9" | 9 5/16" | 1" x 36" x 4" | 14" | 13" | 37,500 | 1,200 |
| MBRX11.7 | 38'5" | 9 3/4" | 1" x 36" x 4" | 14" | 13" | 43,000 | 1,700 |
| MBRX12 | 39'4" | 11 3/8" | 1" x 36" x 4" | 15" | 14" | 47,640 | 1,800 |
| MBRX13 | 42'8" | 11 15/16" | 1" x 36" x 4" | 16 1/2" | 16" | 51,050 | 2,100 |
| MBRX14 | 45'11" | 12 7/16" | 1" x 36" x 4" | 16 1/2" | 16" | 54,680 | 2,350 |
| MBRX15* | 49'2" | 13" | 1" x 36" x 4" | 17 1/2" | 17" | 57,500 | 2,700 |
| MBRX16* | 52'6" | 13 1/2" | 1" x 36" x 4" | 17 1/2" | 17" | 62,700 | 3,150 |

*MBRX15 and MBRX16 are only available from the Everett Plant.

Specifications: Use Centrecon specifications.

Colors and finishes: See Centrecon color selection guide.

Luminaire mounting: See mounting options section for more information.

Anti-graffiti and sealer: Optional coatings available for added protection.

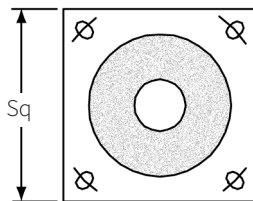

Standard base plate prestressed to pole

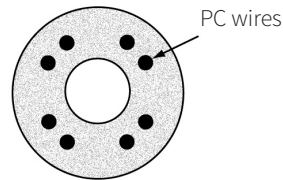

Shaft cross section detail

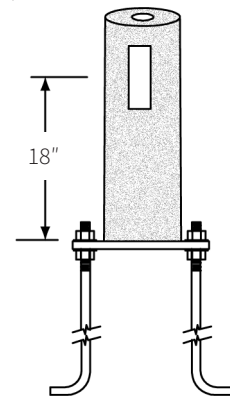

Elevation
See recommended "Capping Detail"

Ameron

Centrecon M-Series Square Poles

Available in base plate and embedded styles

Our versatile Ameron M-Series poles provide the strength needed for street lighting, parking lots, area security lighting, and similar applications. Mounting options include post top, mast arm, or side mounted.

Features and Benefits

- Prestressed steel and highest quality concrete are centrifugally cast for ultimate strength and long-term durability
- Natural stone and terrazzo aggregates maintain a like-new appearance with virtually no maintenance
- Conforms to applicable sections of ACI, AASHTO, ASTM, and PCI standards
- Exclusive 10-year warranty

Colors and Finishes

A wide range of standard, preformulated, and custom colors are available. The concrete shafts are lightly blasted to expose the texture and beauty of the natural stone. See separate aggregates and finishes sheet for details. We offer Amershield, a premium graffiti-resistant coating, as well as other durable sealers and protectants that further enhance colors, protect the concrete surface, and aid in the removal of graffiti.

Durability with a classic touch



Ameron Centrecon M-Series Square Poles

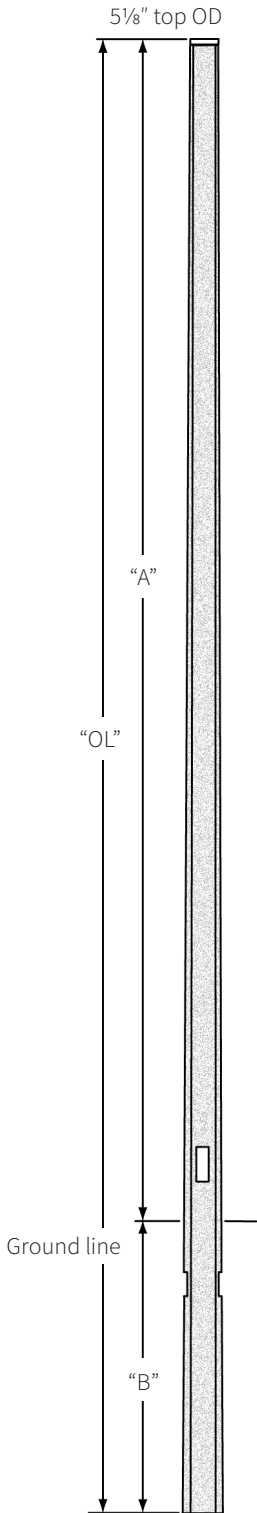

Embedded style

Base plate style - information

| Catalog number | Pole height "A" | Base OD | Anchor bolt | Bolt circle | Base plate (Sq) | Ultimate GL moment (ft/lb) | Pole weight (lb) |
|----------------|-----------------|---------------------------------|--|----------------------------------|-----------------|----------------------------|------------------|
| MBQ07 | 23' | 7 ⁷ / ₈ " | 1" x 36" x 4" | 13" | 12" | 26,320 | 1,000 |
| MBQ07.5 | 24'7" | 8 ¹ / ₆ " | 1" x 36" x 4" | 13" | 12" | 26,850 | 1,120 |
| MBQ08.5 | 27'11" | 8 ⁷ / ₆ " | 1" x 36" x 4" | 14" | 13" | 28,100 | 1,330 |
| MBQ09 | 29'6" | 8 ⁵ / ₆ " | 1" x 36" x 4" | 15" | 14" | 28,800 | 1,450 |
| MBQX10 | 32'10" | 9 ¹ / ₆ " | 1" x 36" x 4" | 15 ¹ / ₂ " | 14" | 36,000 | 1,670 |
| MBQX11 | 36'1" | 9 ⁷ / ₆ " | 1" x 36" x 4" | 15 ¹ / ₂ " | 14" | 36,000 | 1,880 |
| MBQX12.2 | 40' | 9 ¹ / ₆ " | 1" x 36" x 4" | 16 ¹ / ₂ " | 15" | 47,400 | 2,150 |
| MBQX15 | 49'3" | 11" | 1 ¹ / ₄ " x 48" x 6" | 18" | 17" | 58,500 | 2,500 |

Embedded style - information

| Catalog number | Pole height "A" | Bottom OD | Embedded depth "B" | Overall length "OL" | Ultimate GL moment (ft/lb) | Pole weight (lb) |
|----------------|-----------------|---------------------------------|--------------------|---------------------|----------------------------|------------------|
| MEQ06 | 19'8" | 8 ¹ / ₆ " | 4'11" | 24'7" | 25,920 | 1,150 |
| MEQ07 | 23' | 8 ³ / ₆ " | 4'11" | 27'11" | 26,320 | 1,250 |
| MEQ07.5 | 24'7" | 8 ⁹ / ₆ " | 4'11" | 29'6" | 26,850 | 1,350 |
| MEQ08.5 | 27'11" | 9" | 4'11" | 32'10" | 28,100 | 1,570 |
| MEQX09.4 | 30'10" | 9 ¹ / ₄ " | 5'3" | 36'1" | 32,500 | 1,775 |
| MEQX10.6 | 34'9" | 9 ⁷ / ₆ " | 5'3" | 40' | 44,160 | 2,050 |
| MEQX12.2 | 40' | 11" | 9'3" | 49'3" | 47,400 | 2,760 |

Specifications: Use Centrecon specifications.

Colors and finishes: See Centrecon color selection guide.

Luminaire mounting: See Mounting options section for more information.

Anti-graffiti and sealer: Optional coatings are available for added protection.

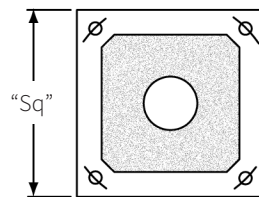

Standard base plate prestressed to pole

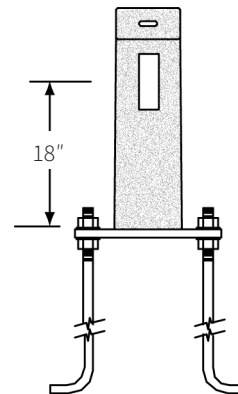

MBQ elevation

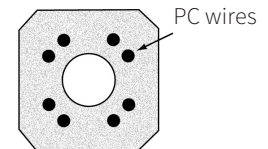

Shaft cross section detail

Ameron

Centrecon S-Series Hexagonal Poles

Available in base plate and embedded styles

Our Ameron S-Series poles are well suited for light duty applications such as shopping centers, parking lots, green belts, and similar areas. Application can be post top or side mounted. Ameron poles are constructed with the highest quality materials and workmanship to ensure uniformity and long term structural integrity.

Features and Benefits

- Prestressed steel and highest quality concrete are centrifugally cast for ultimate strength, durability, and vibration resistance
- Natural stone and terrazzo aggregates maintain a like-new appearance with virtually no maintenance
- Conforms to applicable sections of ACI, AASHTO, ASTM and PCI standards
- Exclusive 10-year warranty

Colors and Finishes

A wide range of standard, preformulated, and custom colors are available. The concrete shafts are lightly blasted to expose the texture and beauty of the natural stone. See separate aggregates and finishes sheet for details. We offer Amershield, a premium graffiti-resistant coating, as well as other durable sealers and protectants that further enhance colors, protect the concrete surface, and aid in the removal of graffiti.

Durability with a classic touch



Ameron Centrecon S-Series Hexagonal Poles

4" top OD
across the flats

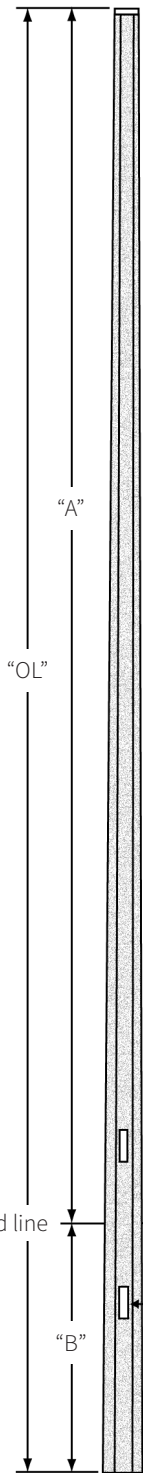

Base plate style - information

| Catalog number | Pole height "A" | Base OD | Anchor bolt | Bolt circle | Base plate (Sq) | Ultimate GL moment (ft/lb) | Pole weight (lb) |
|----------------|-----------------|--------------------|----------------------------|--------------------|-----------------|----------------------------|------------------|
| SBH05.5 | 18' | 6 $\frac{1}{16}$ " | $\frac{3}{4}$ " x 24" x 4" | 10" | 10" | 8,400 | 350 |
| SBH05.8 | 19' | 7" | $\frac{3}{4}$ " x 24" x 4" | 10" | 10" | 9,000 | 400 |
| SBH07.3 | 24' | 7 $\frac{3}{4}$ " | 1" x 36" x 4" | 11 $\frac{1}{2}$ " | 11" | 11,800 | 500 |
| SBHX08.8 | 29' | 8 $\frac{5}{8}$ " | 1" x 36" x 4" | 12 $\frac{1}{2}$ " | 12" | 22,500 | 600 |

Embedded style - information

| Catalog number | Pole height "A" | Bottom OD | Embedded depth "B" | Overall length "OL" | Ultimate GL moment (ft/lb) | Pole weight (lb) |
|----------------|-----------------|--------------------|--------------------|---------------------|----------------------------|------------------|
| SEH04.3 | 14' | 6 $\frac{1}{16}$ " | 4' | 18' | 7,100 | 350 |
| SEH04.6 | 15' | 7" | 4' | 19' | 7,700 | 380 |
| SEH05.8 | 19' | 7 $\frac{3}{4}$ " | 5' | 24' | 9,000 | 470 |
| SEH07.3 | 24' | 8 $\frac{5}{8}$ " | 5' | 29' | 11,800 | 580 |

Specifications: Use Centrecon specifications.

Colors and finishes: See Centrecon color selection guide.

Luminaire mounting: See mounting options section for more information.

Anti-graffiti and sealer: Optional coatings are available for added protection.

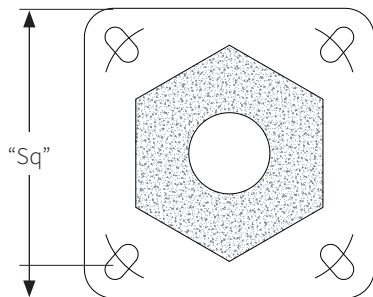

Slotted base plate prestressed pole

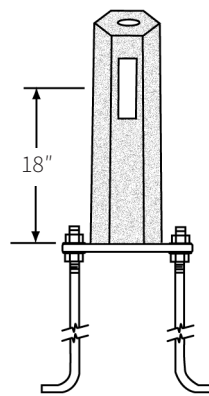

Elevation
See recommended "Capping Detail"

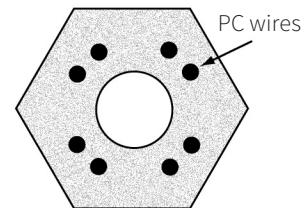

Shaft cross section detail

Ameron

Centrecon S-Series Octagonal Poles

Available in base plate and embedded styles

Our S-Series poles are well suited for light duty applications such as shopping centers, parking lots, green belts, and similar areas. Application can be post top or side mounted. Ameron poles are constructed with the highest quality materials and workmanship to ensure uniformity and long term structural integrity.

Features and Benefits

- Prestressed steel and highest quality concrete are centrifugally cast for ultimate strength, durability, and vibration resistance
- Natural stone and terrazzo aggregates maintain a like-new appearance with virtually no maintenance
- Conforms to applicable sections of ACI, AASHTO, ASTM and PCI standards
- Exclusive 10-year warranty

Colors and Finishes

A wide range of standard, preformulated, and custom colors are available. The concrete shafts are lightly blasted to expose the texture and beauty of the natural stone. See separate aggregates and finishes sheet for details. We offer Amershield, a premium graffiti-resistant coating, as well as other durable sealers and protectants that further enhance colors, protect the concrete surface, and aid in the removal of graffiti.

Durability with a classic touch



Ameron Centrecon S-Series Octagonal Poles

3½" top OD
across the flats

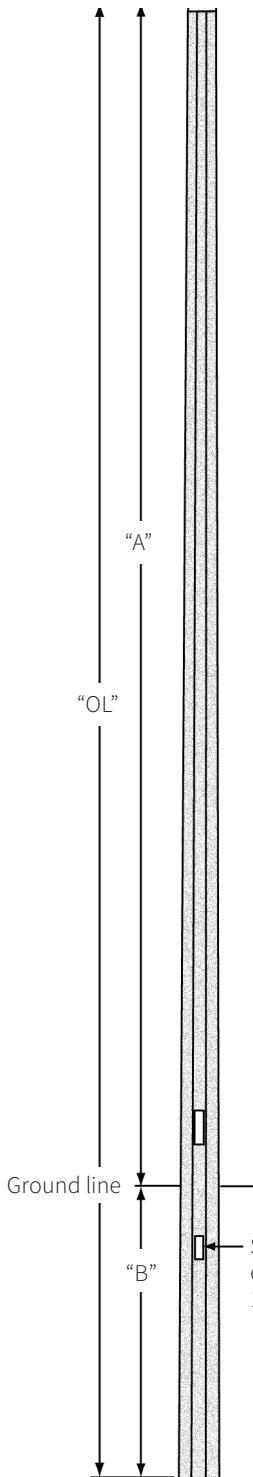

Base plate style - information

| Catalog number | Pole height "A" | Base OD | Anchor bolt | Bolt circle | Base plate (Sq) | Ultimate GL moment (ft/lb) | Pole weight (lb) |
|----------------|-----------------|---------|---------------|-------------|-----------------|----------------------------|------------------|
| SBO04 | 13'1" | 5½" | ¾" x 24" x 4" | 10" | 9" | 6,960 | 220 |
| SBO05 | 16'5" | 6⅞" | ¾" x 24" x 4" | 10" | 9" | 8,400 | 300 |
| SBO05.5 | 18' | 6⅞" | ¾" x 24" x 4" | 10" | 9" | 9,180 | 340 |
| SBO06 | 19'8" | 6⅞" | ¾" x 24" x 4" | 10" | 9" | 9,960 | 400 |
| SBO07 | 23' | 7⅜" | ¾" x 24" x 4" | 10" | 9" | 11,630 | 480 |
| SBO08.3 | 27'3" | 7⅞" | ¾" x 24" x 4" | 11½" | 11" | 12,300 | 620 |

Embedded style - information

| Catalog number | Pole height "A" | Bottom OD | Embedded depth "B" | Overall length "OL" | Ultimate GL moment (ft/lb) | Pole weight (lb) |
|----------------|-----------------|-----------|--------------------|---------------------|----------------------------|------------------|
| SEO03 | 9'10" | 5½" | 3'3" | 13'1" | 5,120 | 250 |
| SEO04 | 13'1" | 6⅞" | 3'3" | 16'4" | 6,960 | 280 |
| SEO04.3 | 14'1" | 6⅞" | 4' | 18'1" | 7,080 | 330 |
| SEO04.6 | 15' | 6⅞" | 4' | 19' | 7,200 | 360 |
| SEO05 | 16'5" | 6⅞" | 3'7" | 20' | 8,400 | 380 |
| SEO06 | 19'8" | 7⅜" | 3'11" | 23'7" | 9,960 | 470 |
| SEO07 | 23' | 7⅞" | 4'3" | 27'3" | 11,630 | 570 |

Specifications: Use Centrecon specifications.

Colors and finishes: See Centrecon color selection guide.

Luminaire mounting: See mounting options section for more information.

Anti-graffiti and sealer: Optional coatings available for added protection.

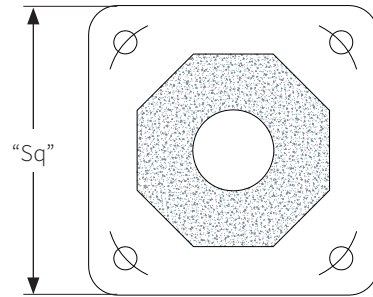

Slotted base plate
prestressed to pole

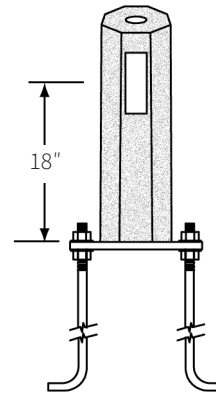

Elevation
See recommended
"capping details"

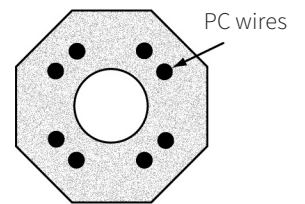

Shaft cross section detail

Ameron

Centrecon S-Series Round Poles

Available in base plate and embedded styles

Our S-Series poles are well suited for light duty applications such as shopping centers, parking lots, green belts, and similar areas. Application can be post top or side mounted. Ameron poles are constructed with the highest quality materials and workmanship to ensure uniformity and long term structural integrity.

Features and Benefits

- Prestressed steel and highest quality concrete are centrifugally cast for ultimate strength, durability, and vibration resistance
- Natural stone and terrazzo aggregates maintain a like-new appearance with virtually no maintenance
- Conforms to applicable sections of ACI, AASHTO, ASTM, and PCI standards
- Exclusive 10-year warranty

Colors and Finishes

A wide range of standard, preformulated, and custom colors are available. The concrete shafts are lightly blasted to expose the texture and beauty of the natural stone. See separate aggregates and finishes sheet for details. We offer Amershield, a premium graffiti-resistant coating, as well as other durable sealers and protectants that further enhance colors, protect the concrete surface, and aid in the removal of graffiti.

Durability with a classic touch



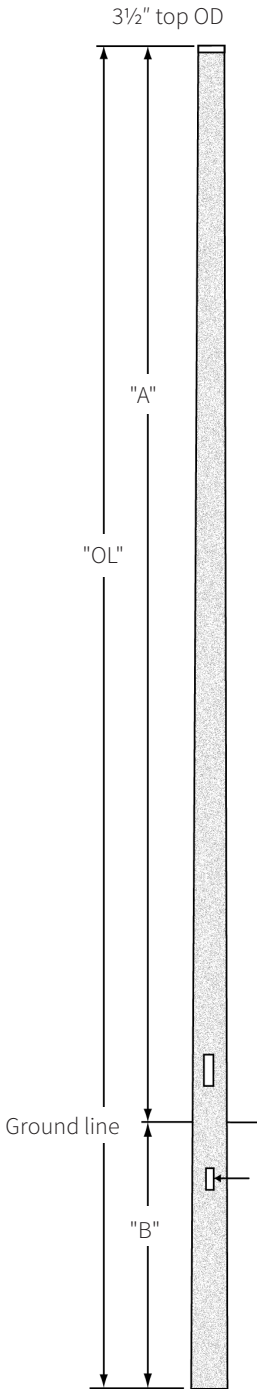

Base plate style - information

| Catalog number | Pole height "A" | Base OD | Anchor bolt | Bolt circle | Base plate (Sq) | Ultimate GL moment (ft/lb) | Pole weight (lb) |
|----------------|-----------------|-----------|-----------------|-------------|-----------------|----------------------------|------------------|
| SBR03.4 | 11'1" | 5 5/16" | 3/4" x 24" x 4" | 10" | 9" | 6,100 | 180 |
| SBR04 | 13'1" | 5 5/8" | 3/4" x 24" x 4" | 10" | 9" | 6,960 | 200 |
| SBR04.3 | 14'1" | 5 5/8" | 3/4" x 24" x 4" | 10" | 9" | 7,080 | 230 |
| SBR05 | 16'5" | 6 1/8" | 3/4" x 24" x 4" | 10" | 9" | 8,400 | 300 |
| SBR05.5 | 18' | 6 7/16" | 3/4" x 24" x 4" | 10" | 9" | 9,180 | 350 |
| SBR06 | 19'8" | 6 1 1/16" | 3/4" x 24" x 4" | 10" | 9" | 9,960 | 400 |
| SBR07 | 23' | 7 3/16" | 3/4" x 24" x 4" | 10" | 9" | 11,630 | 470 |
| SBR08.3 | 27'3" | 7 7/8" | 3/4" x 24" x 4" | 10" | 9" | 12,300 | 580 |

Embedded style - information

| Catalog number | Pole height "A" | Bottom OD | Embedded depth "B" | Overall length "OL" | Ultimate GL moment (ft/lb) | Pole weight (lb) |
|----------------|-----------------|-----------|--------------------|---------------------|----------------------------|------------------|
| SER02.5 | 8'2" | 5 5/16" | 2'11" | 11'1" | 4,200 | 160 |
| SER03 | 9'10" | 5 5/8" | 3'3" | 13'1" | 5,120 | 180 |
| SER04 | 13'1" | 6 1/8" | 3'4" | 16'5" | 6,960 | 280 |
| SER04.3 | 14' | 6 3/8" | 4' | 18' | 7,080 | 330 |
| SER05 | 16'5" | 6 1 1/16" | 3'7" | 20' | 8,400 | 380 |
| SER06 | 19'8" | 7 5/16" | 3'11" | 23'7" | 9,960 | 450 |
| SER07 | 23' | 7 7/8" | 4'3" | 27'3" | 11,630 | 550 |

Specifications: Use Centrecon specifications.

Colors and finishes: See Centrecon color selection guide.

Luminaire mounting: See mounting options section for more information.

Anti-graffiti and sealer: Optional coatings available for added protection.

Single cable entrance
18" below grade

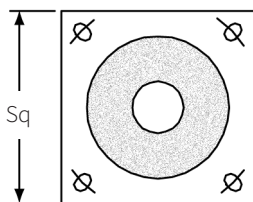

Base plate
prestressed to pole

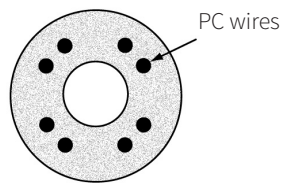

Shaft cross section detail

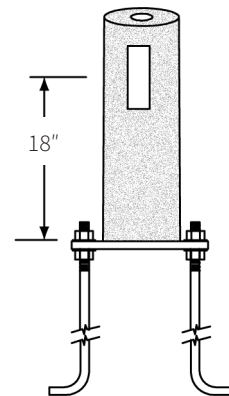

SBR elevation
See recommended "Capping Detail"

Ameron

Centrecon S-Series Square Poles

Available in base plate and embedded styles

Our S-Series poles provide light duty strength typically used for illuminating shopping centers, parks, a school campus, or similar applications. Mounting options include post top or side mounted.

Features and Benefits

- Prestressed steel and highest quality concrete are centrifugally cast for ultimate strength and long-term durability
- Natural stone and terrazzo aggregates maintain a like-new appearance with virtually no maintenance
- Conforms to applicable sections of ACI, AASHTO, ASTM, and PCI standards
- Exclusive 10-year warranty

Colors and Finishes

A wide range of standard, preformulated, and custom colors are available. The concrete shafts are lightly blasted to expose the texture and beauty of the natural stone. See separate aggregates and finishes sheet for details. We offer Amershield, a premium graffiti-resistant coating, as well as other durable sealers and protectants that further enhance colors, protect the concrete surface, and aid in the removal of graffiti.

Durability with a classic touch



Ameron Centrecon S-Series Square Poles

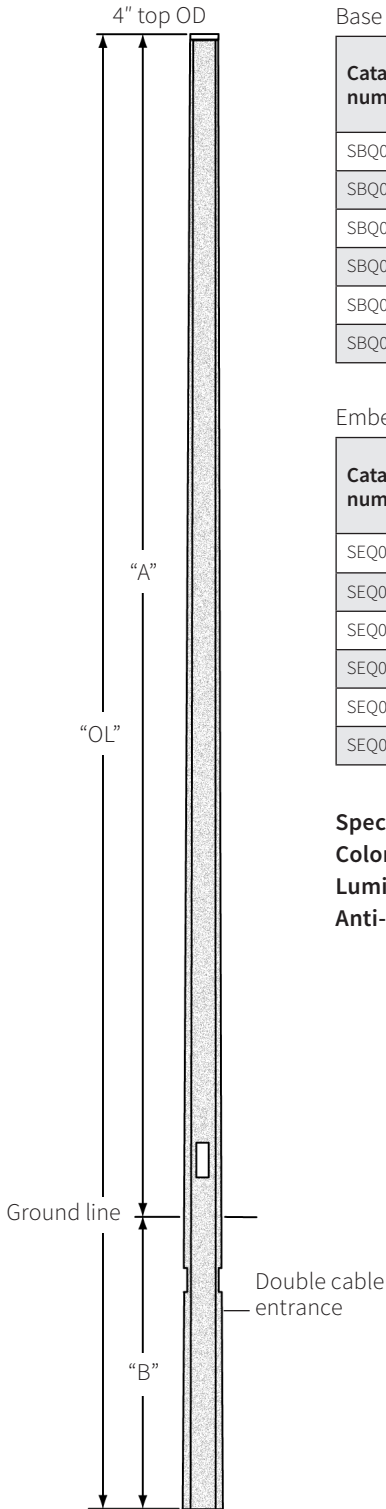

Base plate style - information

| Catalog number | Pole height "A" | Base OD | Anchor bolt | Bolt circle | Base plate (Sq) | Ultimate GL moment (ft/lb) | Pole weight (lb) |
|----------------|-----------------|---------|---------------|-------------|-----------------|----------------------------|------------------|
| SBQ04 | 13'1" | 5½" | ¾" × 24" × 4" | 11½" | 11" | 11,060 | 300 |
| SBQ05 | 16'5" | 5⅞" | ¾" × 24" × 4" | 11½" | 11" | 11,970 | 400 |
| SBQ06 | 19'8" | 6⅜" | ¾" × 24" × 4" | 11½" | 11" | 12,980 | 510 |
| SBQ06.5 | 21'4" | 6½" | ¾" × 24" × 4" | 11½" | 11" | 13,320 | 565 |
| SBQ07 | 23' | 6⅞" | ¾" × 24" × 4" | 11½" | 11" | 13,660 | 620 |
| SBQ07.5 | 24'7" | 6⅞" | ¾" × 24" × 4" | 11½" | 11" | 13,950 | 680 |

Embedded style - information

| Catalog number | Pole height "A" | Bottom OD | Embedded depth "B" | Overall length "OL" | Ultimate GL moment (ft/lb) | Pole weight (lb) |
|----------------|-----------------|-----------|--------------------|---------------------|----------------------------|------------------|
| SEQ03 | 9'10" | 5½" | 3'3" | 13'1" | 9,940 | 270 |
| SEQ04 | 13'1" | 5⅞" | 3'3" | 16'4" | 11,060 | 380 |
| SEQ04.6 | 15' | 6⅜" | 4'8" | 19'8" | 11,950 | 480 |
| SEQ05.2 | 17' | 6½" | 4'3" | 21'3" | 12,980 | 540 |
| SEQ05.7 | 18'8" | 6⅞" | 4'4" | 23' | 13,300 | 610 |
| SEQ06 | 19'8" | 6⅞" | 4'11" | 24'7" | 13,750 | 680 |

Specifications: Use Centrecon specifications.

Colors and finishes: See Centrecon color selection guide.

Luminaire mounting: See mounting options section for more information.

Anti-graffiti and sealer: Optional coatings are available for added protection.

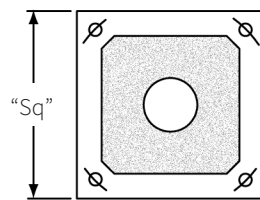

Base plate

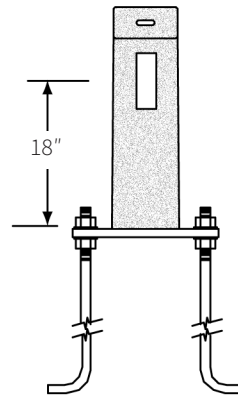

SBQ elevation
See recommended
"Capping Detail"

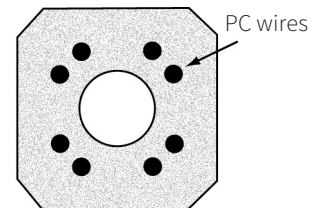

Shaft cross
section detail

National Oilwell Varco has produced this brochure for general information only, and it is not intended for design purposes. Although every effort has been made to maintain the accuracy and reliability of its content, National Oilwell Varco does not warrant the accuracy or completeness of any data or information contained herein. National Oilwell Varco in no way assumes responsibility for any claim or liability for any loss, damage or injury related to or arising from the use and/or interpretation of the data and information contained herein. The user retains full responsibility for all inferences drawn or decisions made in connection with any such information and data or interpretations of such information and data, and all applications for the material described are at the user's risk and are the user's responsibility.

Pole Products
1020 B Street
Fillmore, CA 93015, USA

Contact us
800.552.6376